

Installation Instructions

Wraysbury Backlit Panel 1200x600

Input	220-240V 50/60Hz
Power	48W
Operating Temp	0-40°C
Connection Type	Loch3 Connector
Emergency Option	430451 (Sold Separately)
Control Connection	N/A
Light Source Energy Rating	C

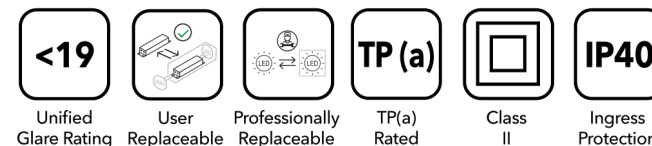
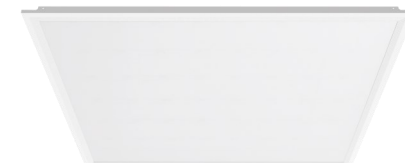

Box Contents:

- Wraysbury Panel
- LED Driver
- Loch3 Connector

Tools Required For Installation:

- Wire Strippers / Cutters
- Screwdriver



Dimensions:

Part No.	Description	L (mm)	W (mm)	H (mm)	Weight
431274	Wraysbury Backlit Panel 48W 3CCT	1195	595	34	3.34Kg

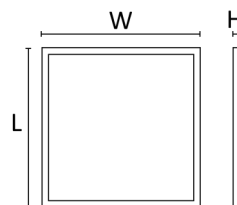

End Of Life Disposal:

Disassembly instructions for end of life disposal available on website.
 Disposal of Electronic Equipment WEEE Directive 2002/96/EC This product falls within the scope of the Waste Electrical & Electronic Equipment Directive (WEEE), which means the product should not be disposed of as normal household waste. Please recycle where facilities exist or check with your Local Authority. RoHS - All components and materials used in this product are RoHS 2002/95/EC compliant. Specifications may change from time to time. The information contained in this leaflet is for guidance only and should not be considered as always accurate and should be treated as not representative.



READ THESE INSTRUCTIONS THOROUGHLY BEFORE INSTALLATION
KEEP THESE INSTRUCTIONS FOR FUTURE REFERENCE.

IMPORTANT:

This product must be installed by a qualified electrician or competent person, and in accordance with current building and IET wiring regulations.

Warranty:

This luminaire is warranted for a period of 5Years from the date of purchase**. The warranty could be invalidated should the light fitting not be installed according to these instructions, outside the scope of the specification or the product has been altered or tampered with in any way. Please see website for terms and conditions.



WARNING: Risk of electric shock!
Isolate the mains power before proceeding.

- Turn off the mains power before performing inspections, installation, or removal
- Verify that the supply voltage is correct by comparing it with the luminaire label information
- It is the installers responsibility to ensure installation is suitable for the total load of the luminaire(s). The supply cable, fuses/circuit breakers must be correctly rated for the electrical load and considering for any transient inrush currents that may occur.
- Do not perform insulation strength or resistance tests on installed luminaire(s) connected

Wiring instructions for units equipped with EMERGENCY function:

Emergency lighting luminaire must be installed and maintained in accordance with the emergency lighting standard BS 5266-1

- For the emergency unit to work correctly, please ensure that an uninterrupted permanent live feed is present and is connected directly to the 'Permanent Live' terminal of the mains terminal block. Please ensure there are no switches, PIRs etc within the permanent live feed, constant switching of the emergency pack could result in premature battery failure.
- Following power up the green LED indicator should illuminate to indicate charging. If power to the unit is disrupted or isolated, the unit indicating green LED will switch off, triggering the emergency LEDs to illuminate.
- When self-test mode is selected, 24hrs from connection to mains power, a 3hrs duration test will be performed automatically.

Installation Procedure:

1. Connect mains cable to the Loch3 Connector as per image.
2. If the driver has been disconnected, re- connect using Jack Connector.
3. Choose CCT setting required, located on supply cable to panel
4. Fit the panel into the desired location.
5. Reconnect the mains supply.

1.

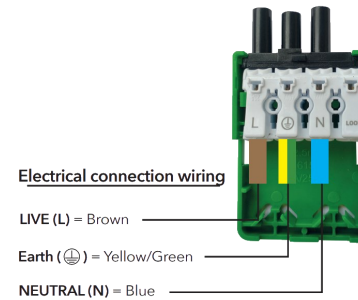

2.

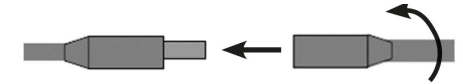

TWIST & LOCK Jack Connector

CAUTION
Do not hot plug when live.

3.

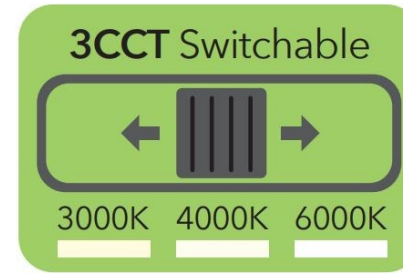

4.

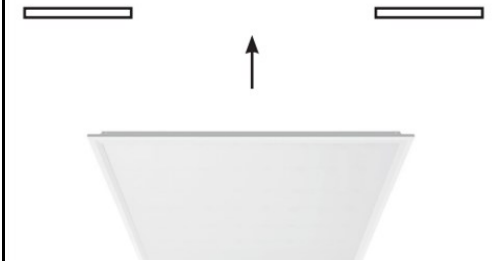

5.

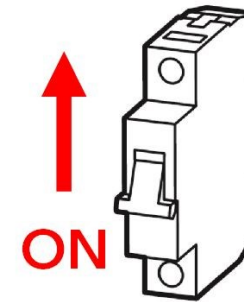

6.

7.

8.